

Quadrilla

Marble Run Construction



E6021



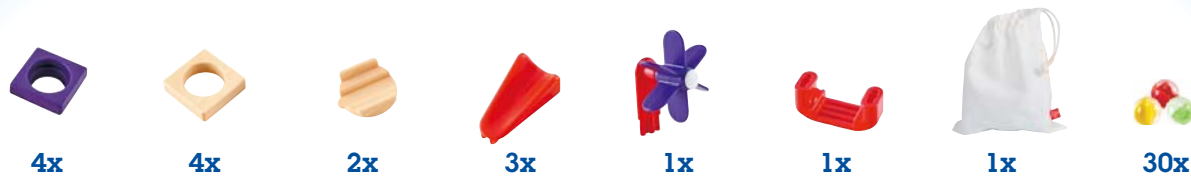

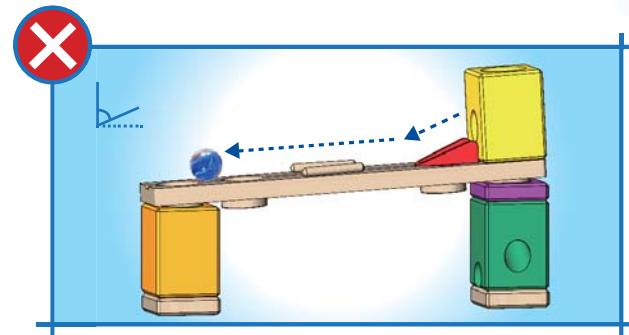
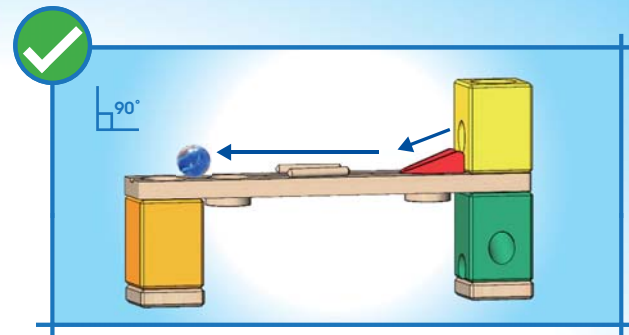
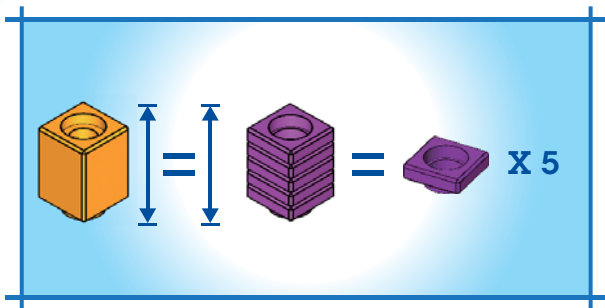
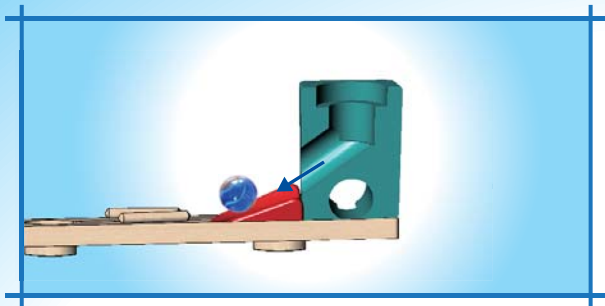

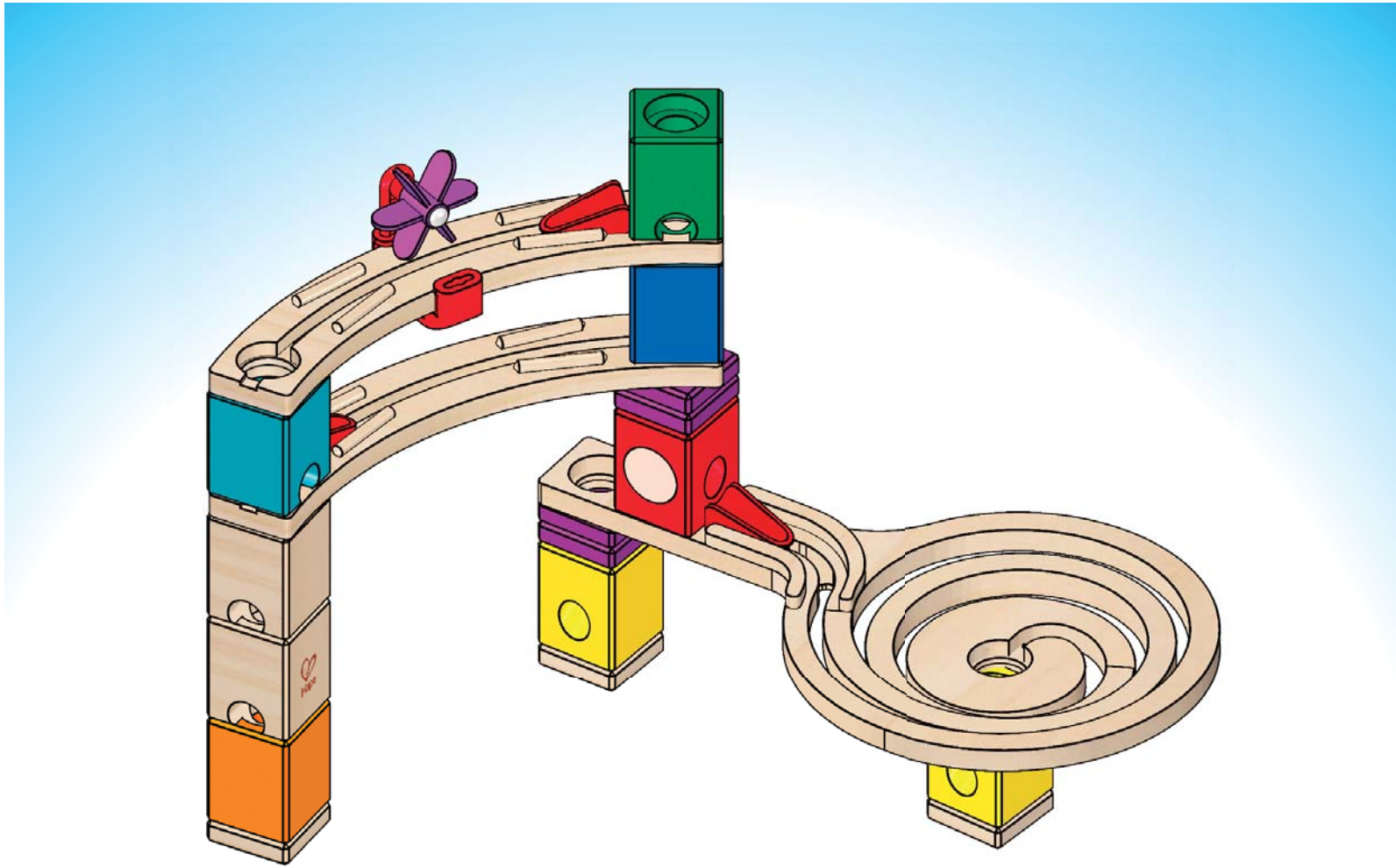

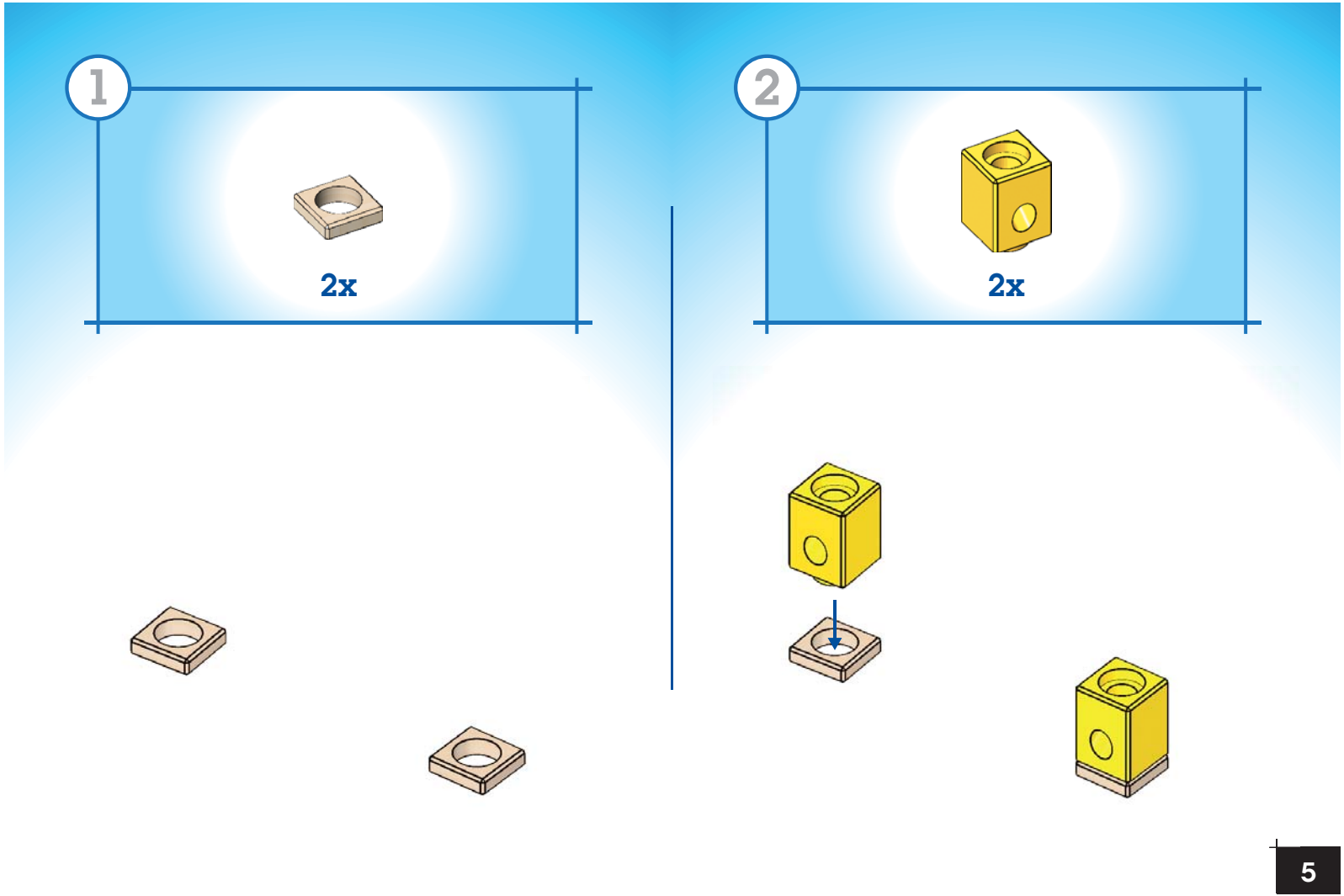

3

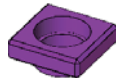

2x

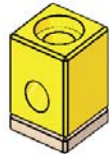
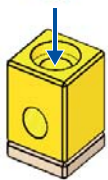
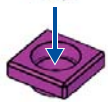

4

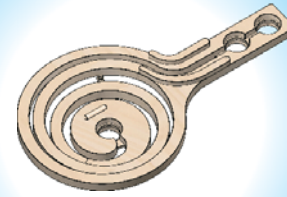

1x

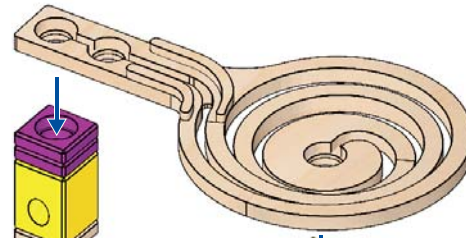

6

5

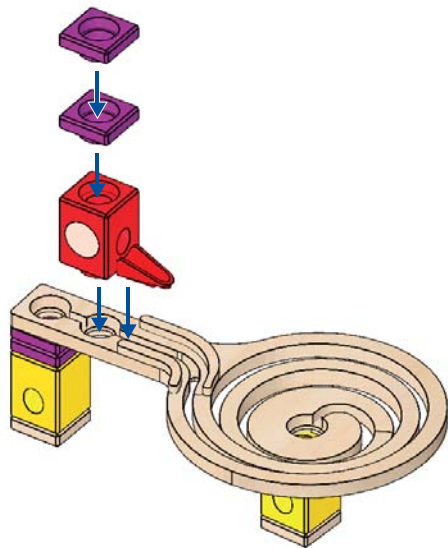
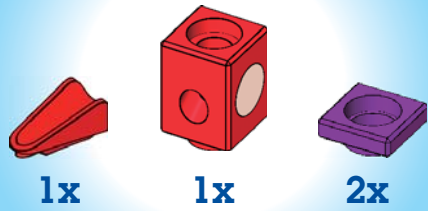

6

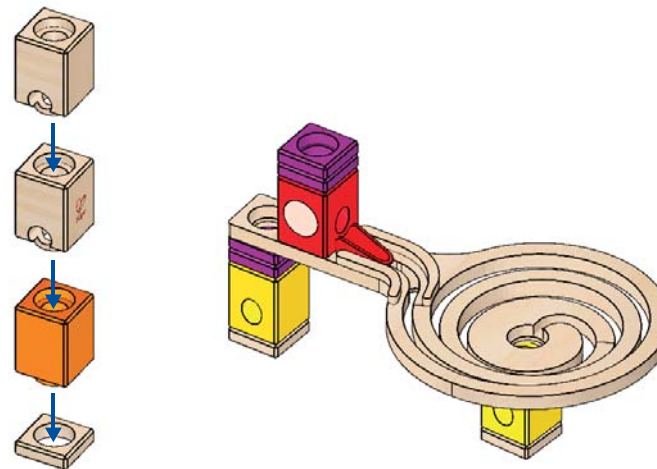
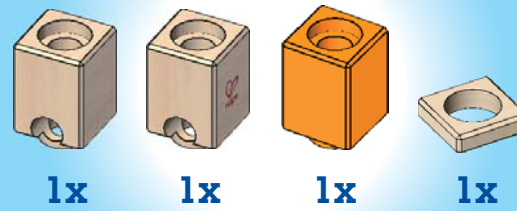

7

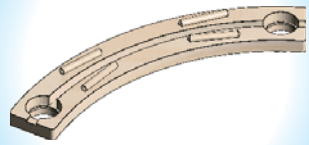

1x

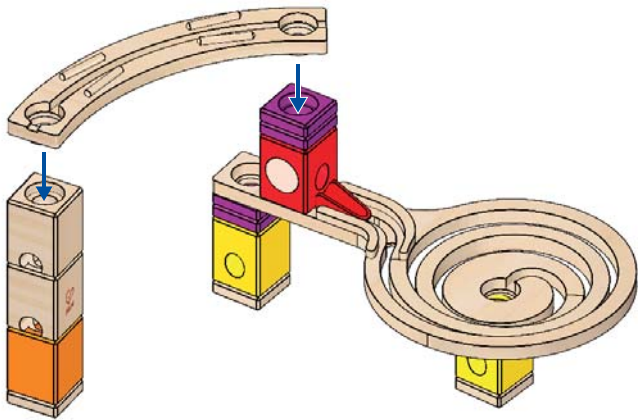

8



1x

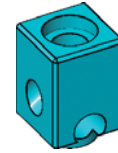

1x

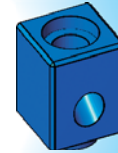

1x

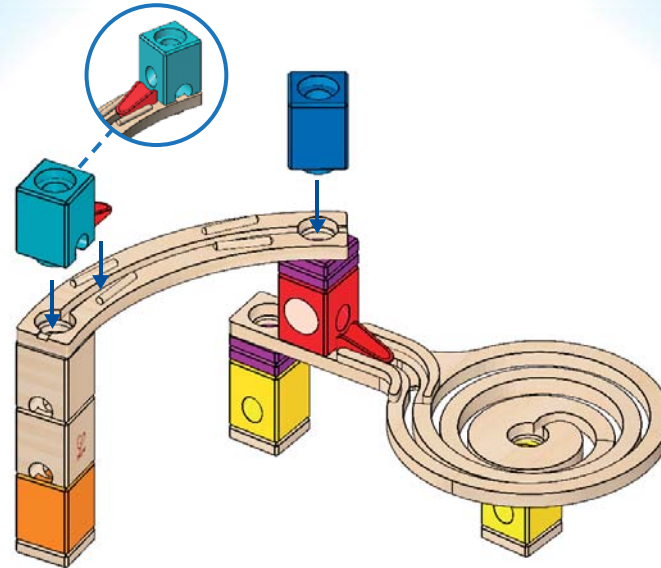

9



1x



1x

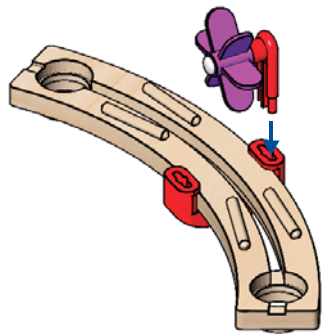
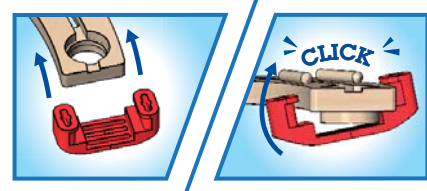

10

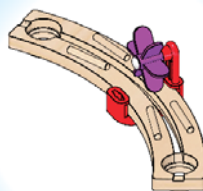

1x

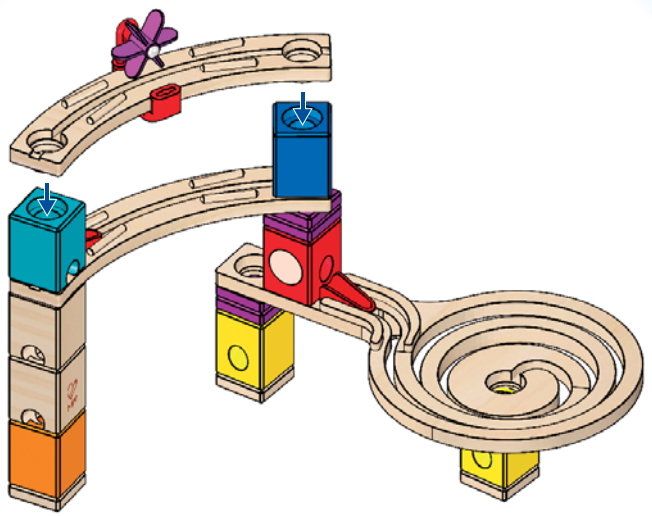

11



1x



1x

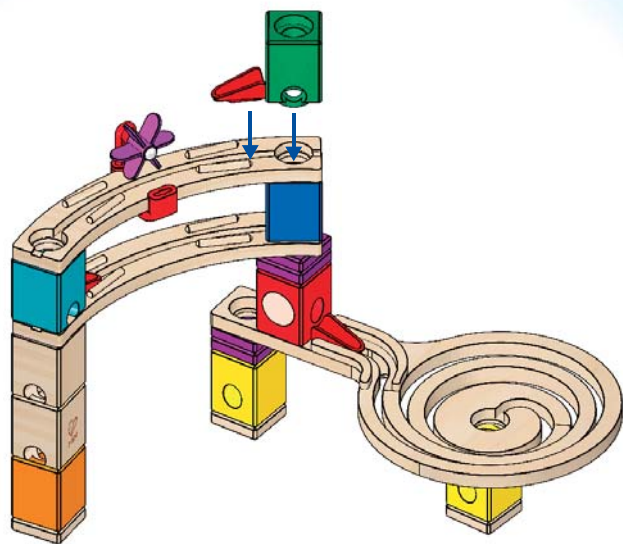

12



1x

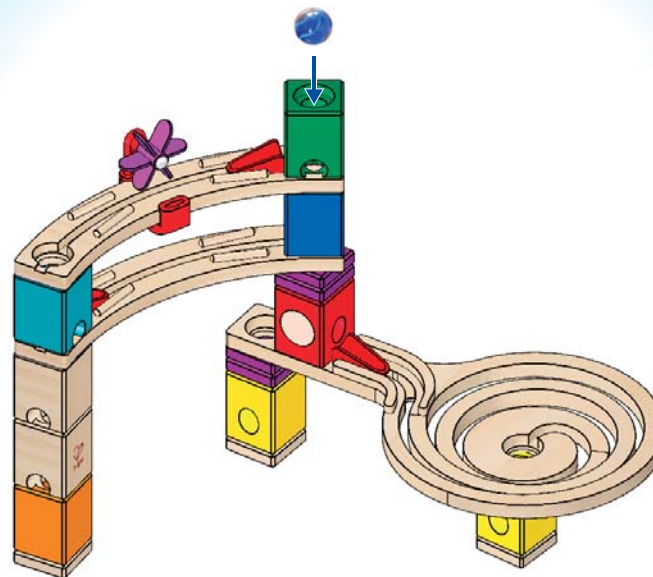

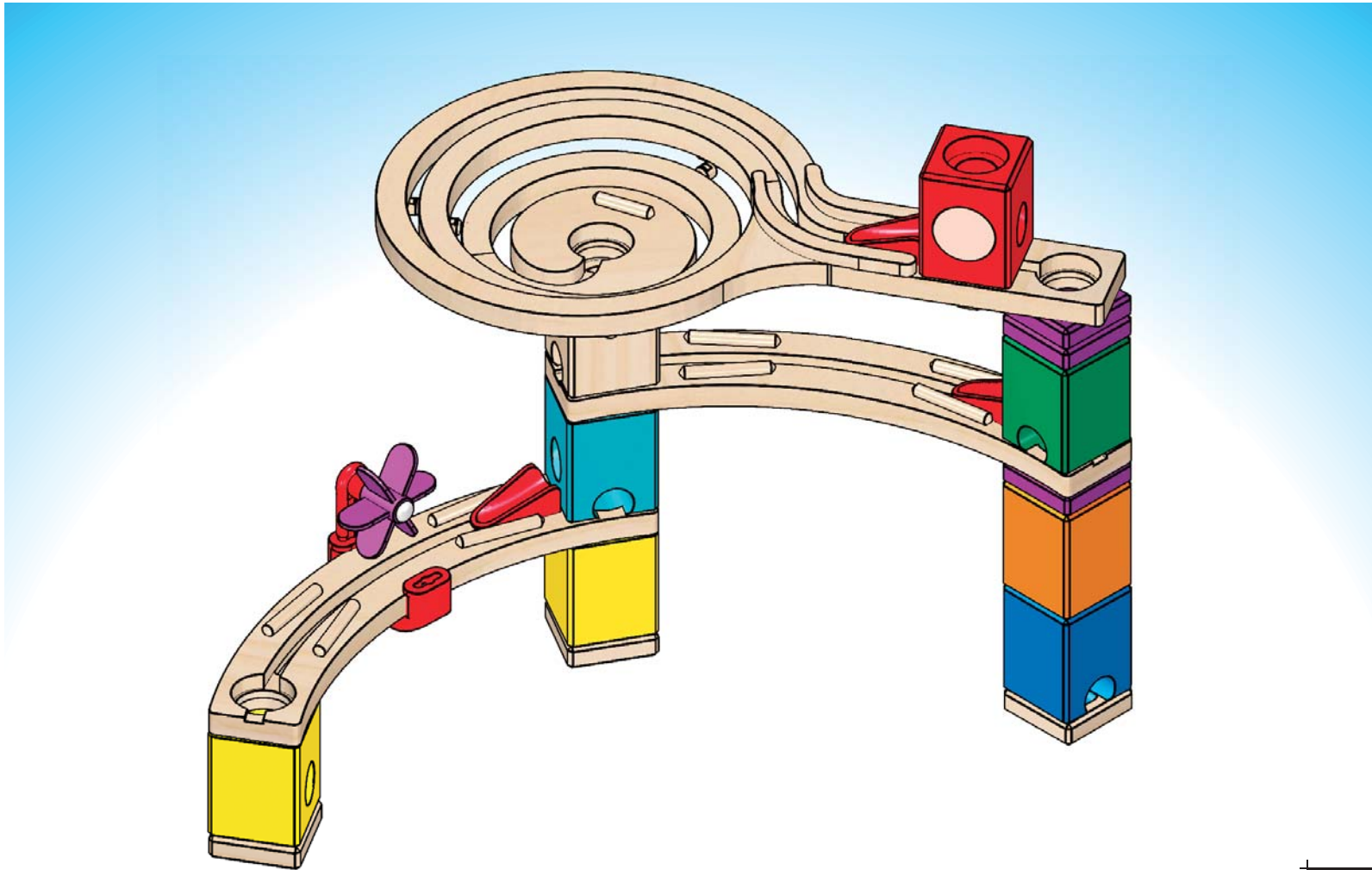

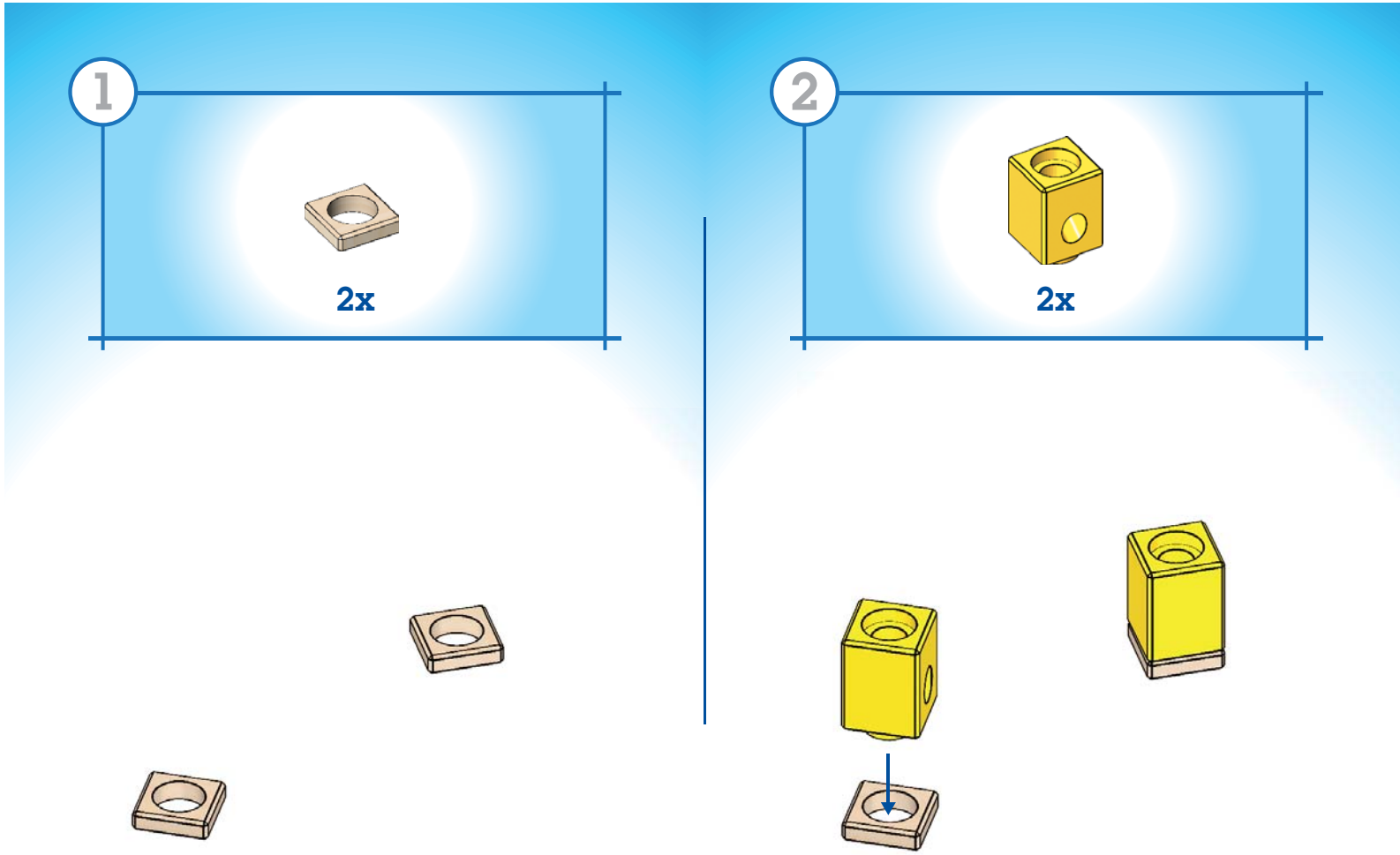

3



1x



1x

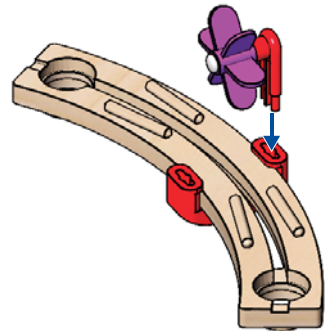
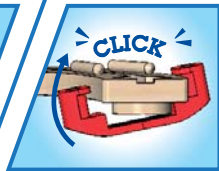
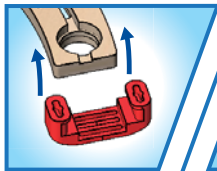

4

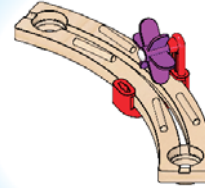

1x

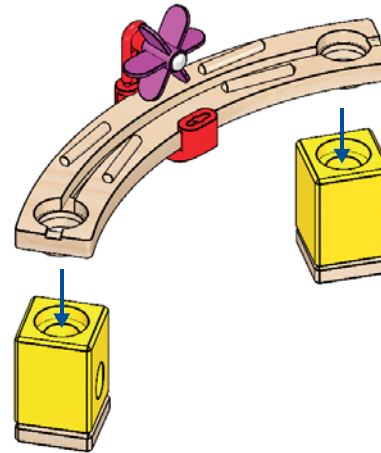

5



1x

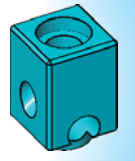

1x

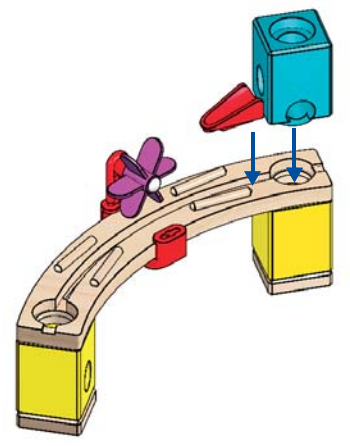

6

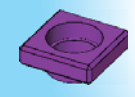

1x

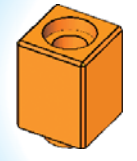

1x

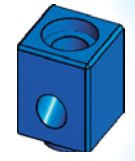

1x

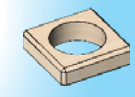

1x

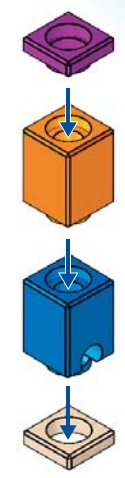
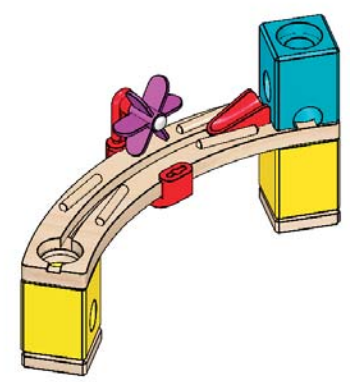

7

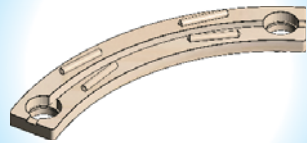

1x

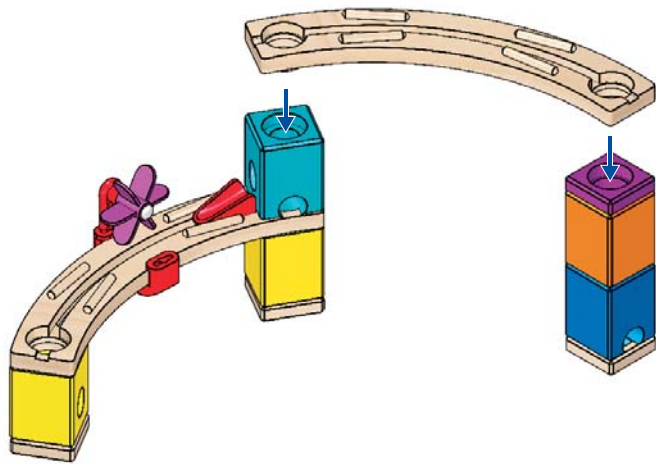

8



1x



1x

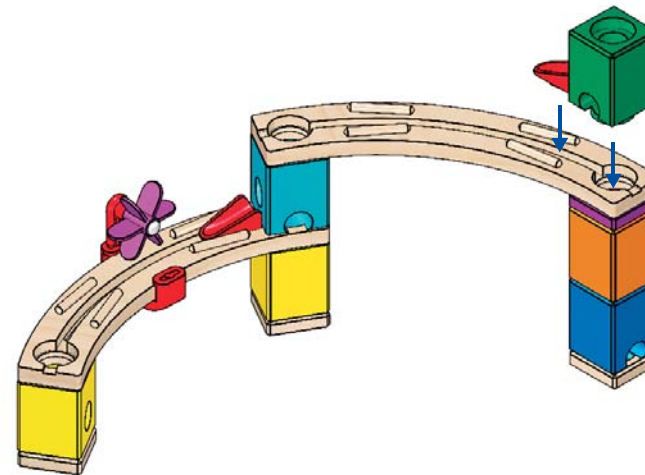

9



1x

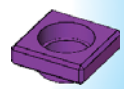

2x

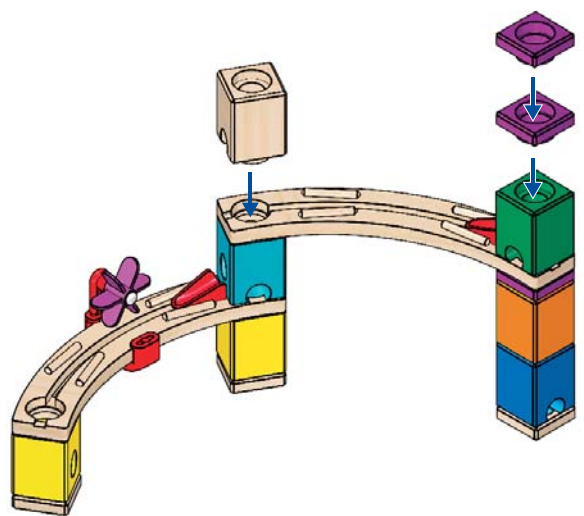

10

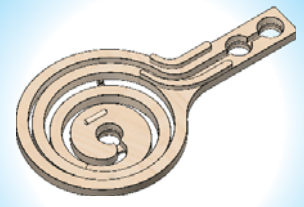

1x

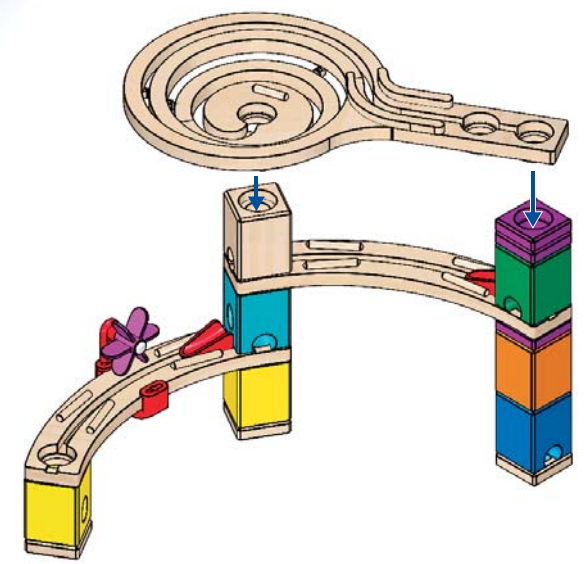

11



1x

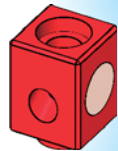

1x

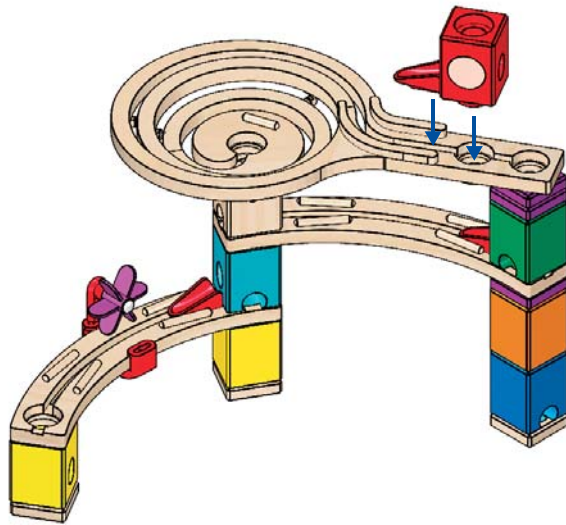

12



1x

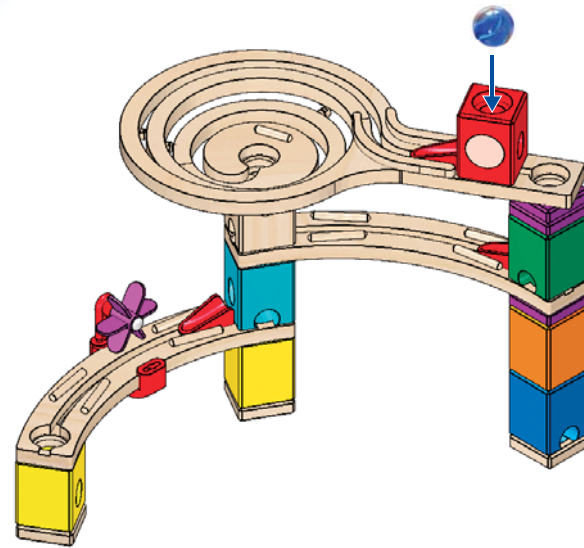

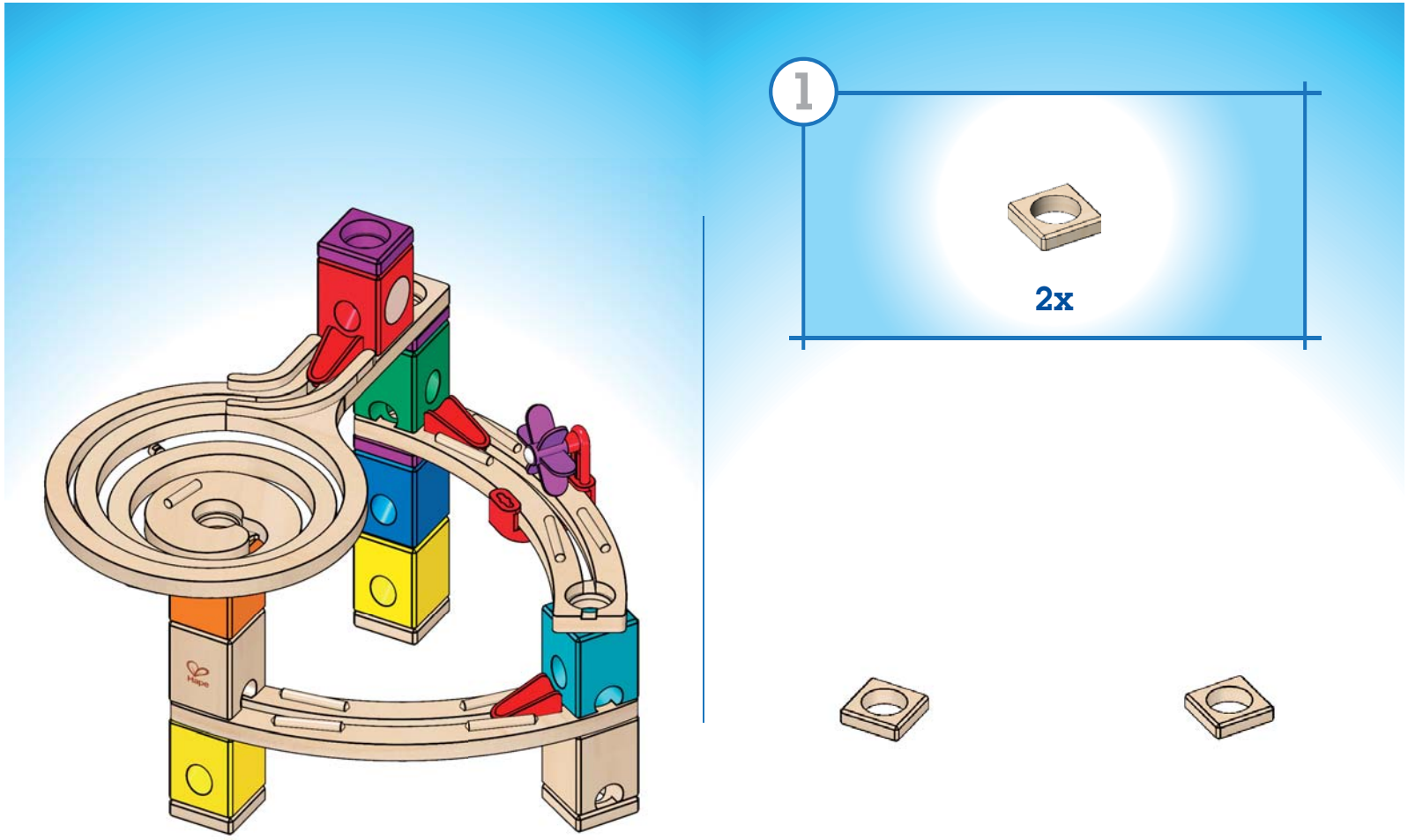

2

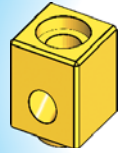

1x



1x

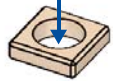

3

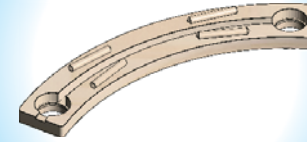

1x



4

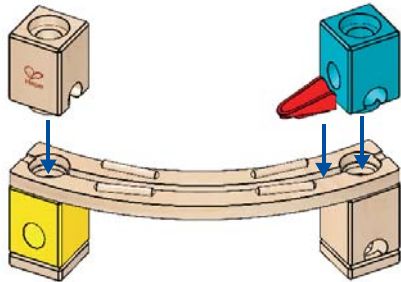
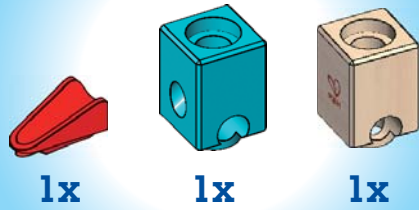

5

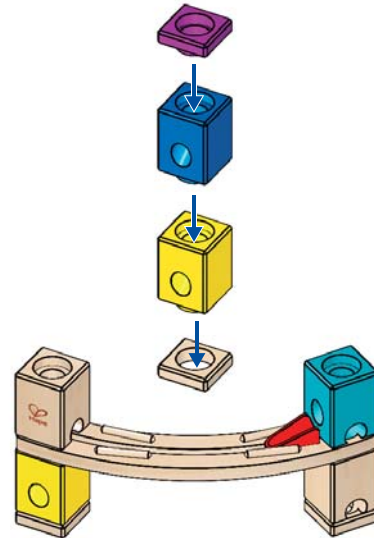
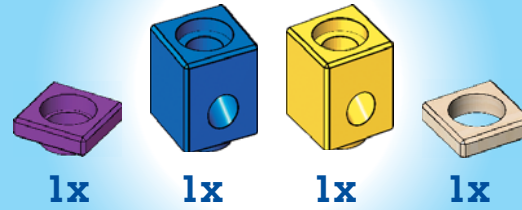

6



1x



1x

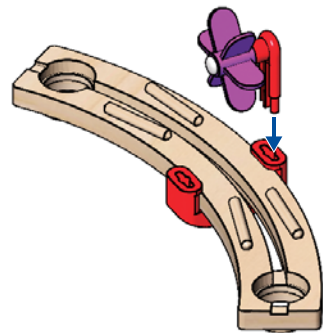
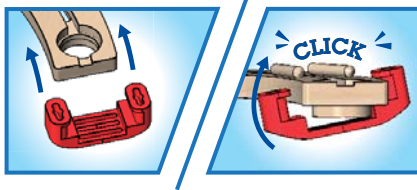

7



1x

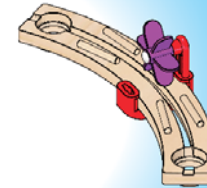

1x

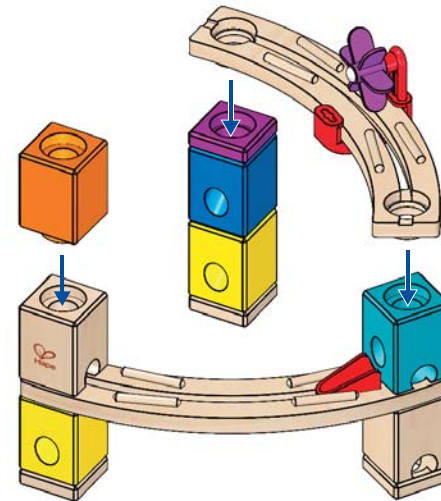

8



1x

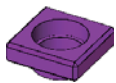

1x



1x

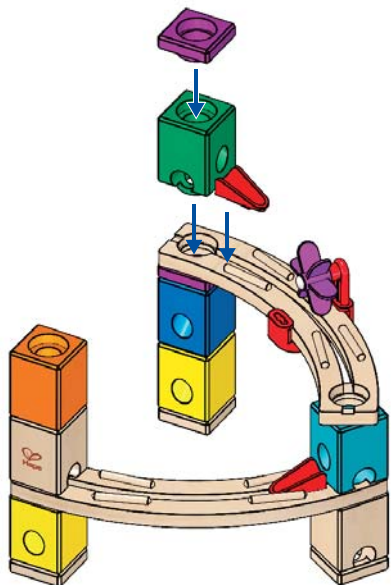

9

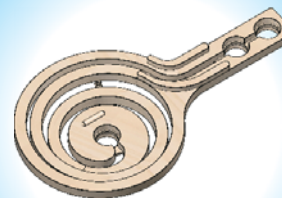

1x

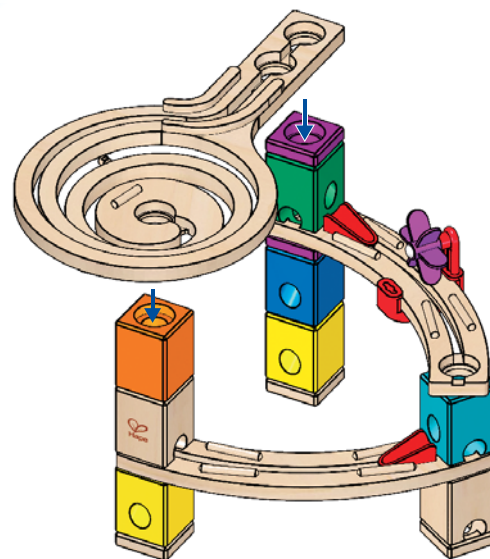

10

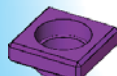

1x



1x

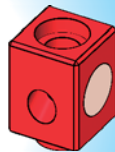

1x

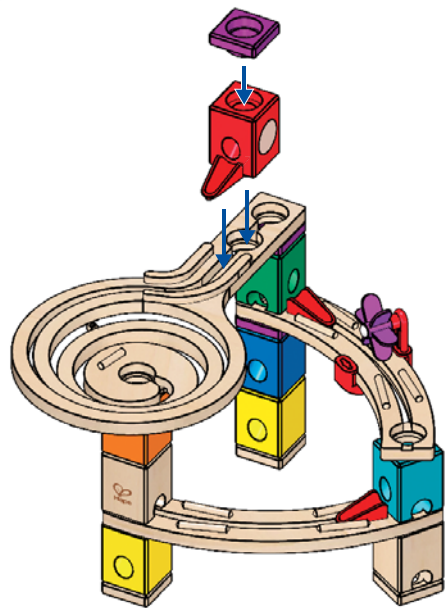

11



1x

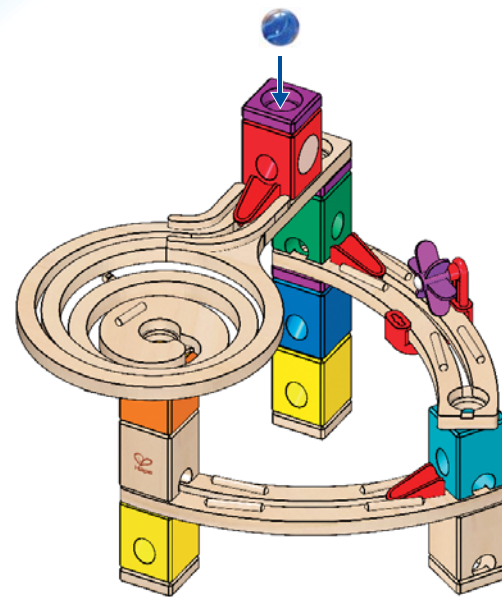



H A P E . C O M

Hape International AG
Alsfelder Straße 41
35325 Mücke
Germany

Hape
1909 Tyler St. #301
Hollywood FL 33020
USA

665337